

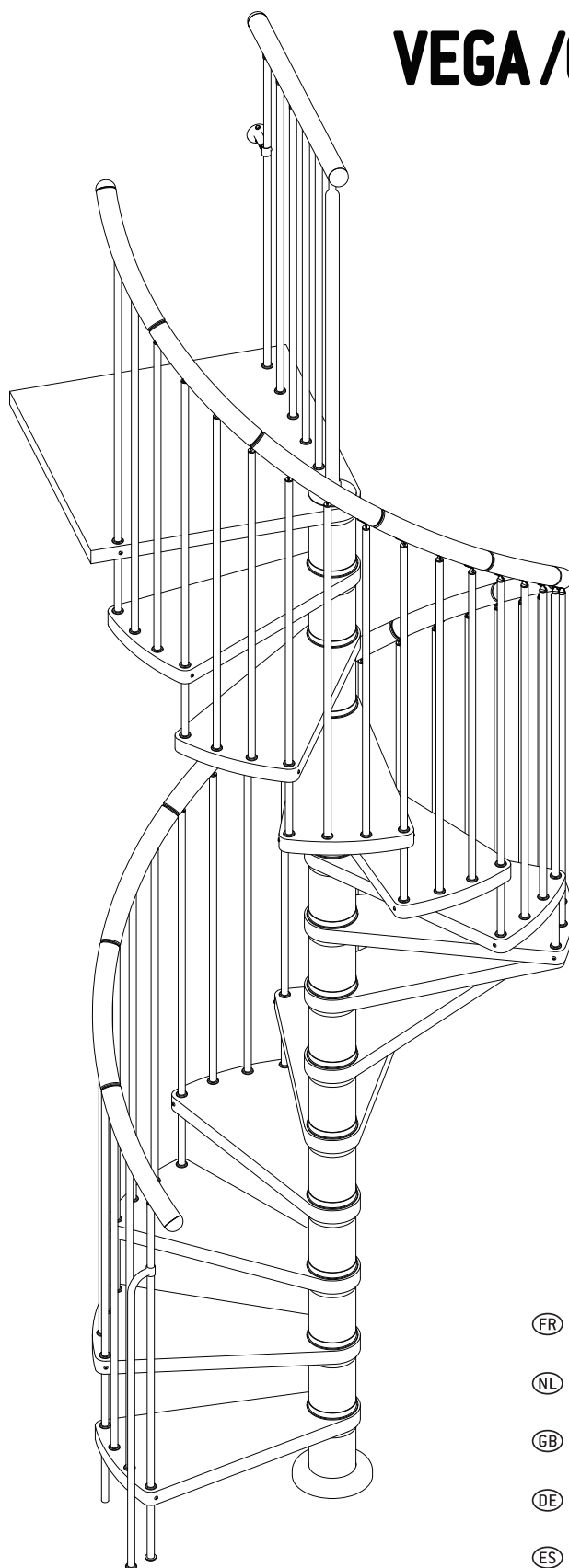

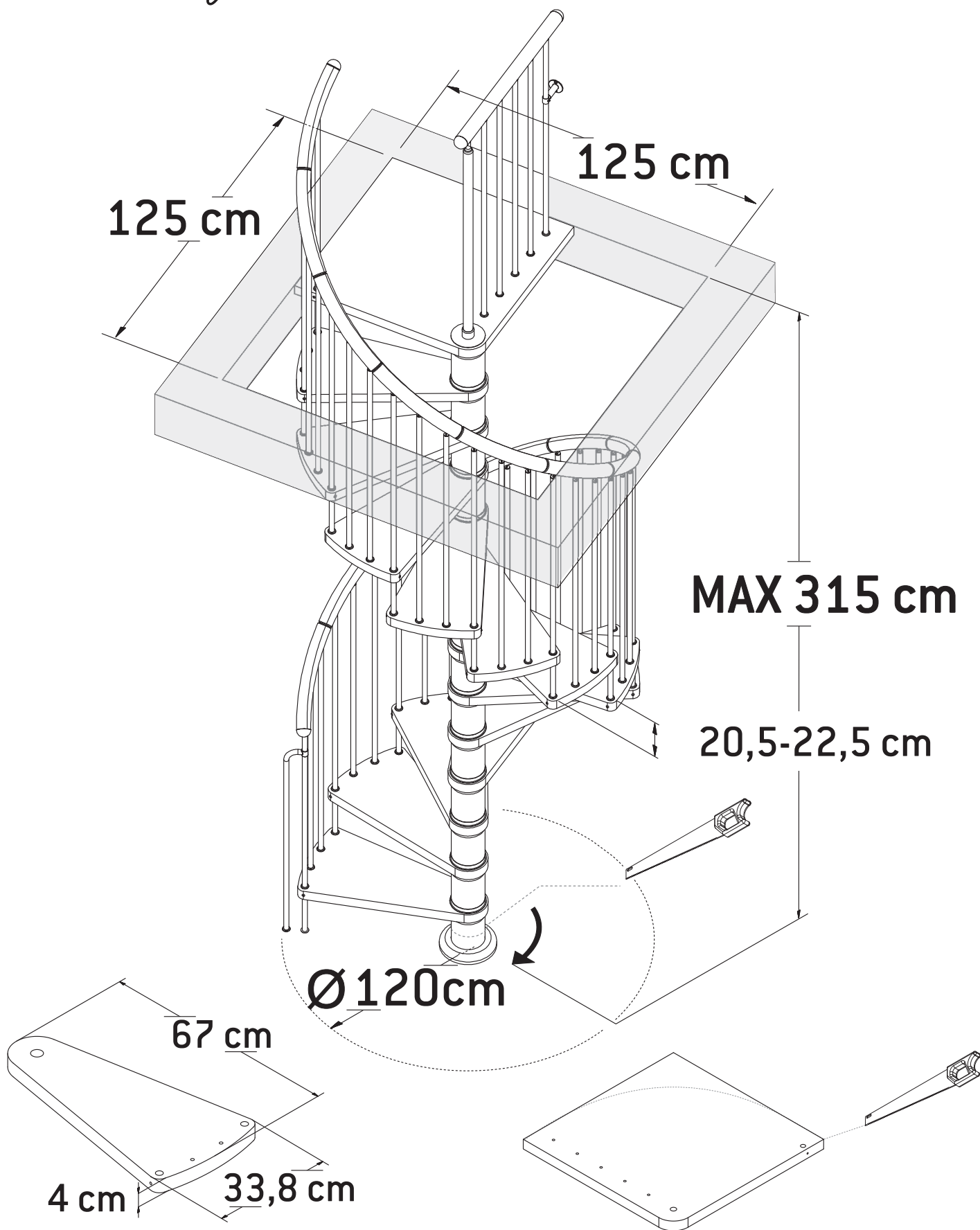

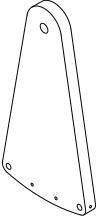

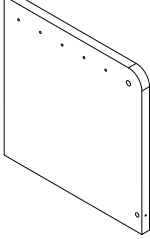

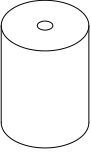
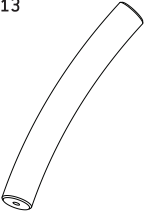











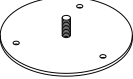







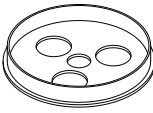

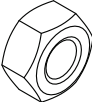









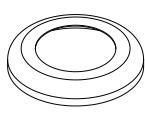
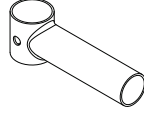
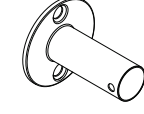

VEGA / COLUMBIA Ø120

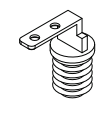

- Ⓕ FR VEGA / COLUMBIA ESCALIER 120 CM
- Ⓕ NL VEGA / COLUMBIA TRAP 120 CM
- Ⓕ GB VEGA / COLUMBIA STAIRCASE 120 CM
- Ⓕ DE TREPPE VEGA / COLUMBIA 120 CM
- Ⓕ ES VEGA / COLUMBIA ESCALERA 120 CM.
- Ⓕ RO VEGA / COLUMBIA SCARA DE 120 CM

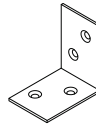
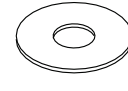
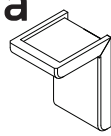
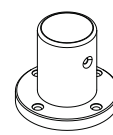

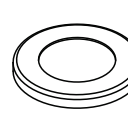
<p>1 40x345x670mm x13</p> 	<p>2 40x720x720mm x1</p> 	<p>3 Ø118x160mm x14</p> 	<p>4 Ø50x370mm x13</p> 	<p>5 Ø50x40mm x4</p> 	<p>6 Ø18x900mm x1</p> 
<p>7 Ø34x955 mm x1</p> 	<p>8 Ø18x1315 mm x1</p> 	<p>9 Ø18x1120 mm x13</p> 	<p>10 Ø18x1013 mm x13</p> 	<p>11 Ø18x938 mm x13</p> 	<p>12 Ø18x955 mm x5</p> 
<p>13 M20x997 mm x1</p> 	<p>14 Ø20x997 mm x2</p> <p>M12</p> 	<p>15 Ø20x220 mm x1</p> <p>M12</p> 	<p>16 Ø192x4 mm x1</p> 	<p>17 M8x40 mm x13</p> 	<p>18 M12x80 mm x3</p> 
<p>19 118x5 mm x56</p> 	<p>20 120x3 mm x1</p> 	<p>21 Ø36x3 mm x1</p> <p>A20</p> 	<p>22 Ø40x4mm x12</p> 	<p>23 Ø16x1.6 mm x31</p> <p>A8</p> 	<p>24 Ø121x18 mm x28</p> 
<p>25 Ø50x765 mm x1</p> 	<p>26 x1</p>  <p>M20</p>	<p>27 Ø10x7 mm x27</p> 	<p>28 Ø28x4 mm x27</p> 	<p>29 Ø28x4 mm x31</p> 	<p>30 Ø4,8x13 x3</p> 
<p>31 Ø6x25 x8</p> 	<p>32 Ø6x60 x14</p> 	<p>33 Ø8x80 x6</p> 	<p>34 M8x60 x31</p> 	<p>35 Ø10x50 x14</p> 	<p>36 Ø12x60 x6</p> 

37 Ø200x33 mm x1 	38 Ø22x82 mm x1 	39 Ø55x60 mm x1 	40 Ø55x60 mm x2 Pz3 	41 Ø18x37 mm x46 	42 Ø3.5x25 mm x92 
43 M6x8 mm x27 	44 18.5x22 mm x12 	45 Ø28x15 mm x3 	46 50x60x90 mm x4 	47 36x4 mm x1 	48 15x60x70 mm 15x60x100 mm x4 a  b
49 Ø73x70 mm x2 	50 Ø4x25mm x4 	51 Ø6x30mm x4 	52 Ø75x12mm x1 	53 Ø40x900 mm x2 M8 	

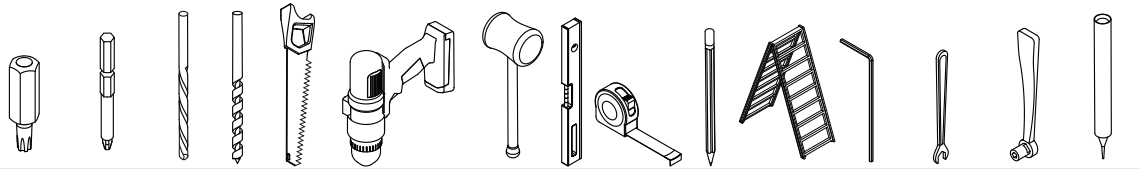

Tx10-30 Ph2/3 Ø10 04
 Pz2/3 Ø12 012

Hex 3 30 13



01

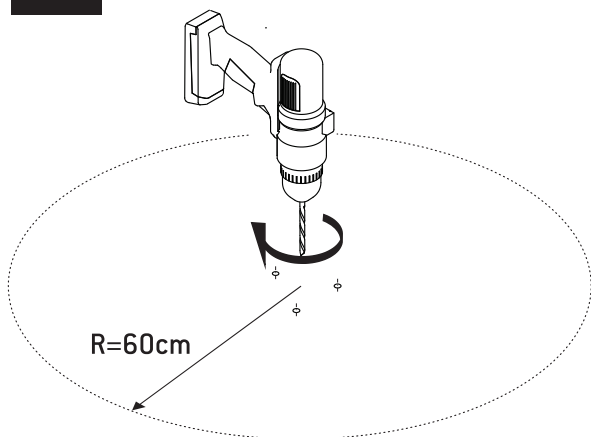

02

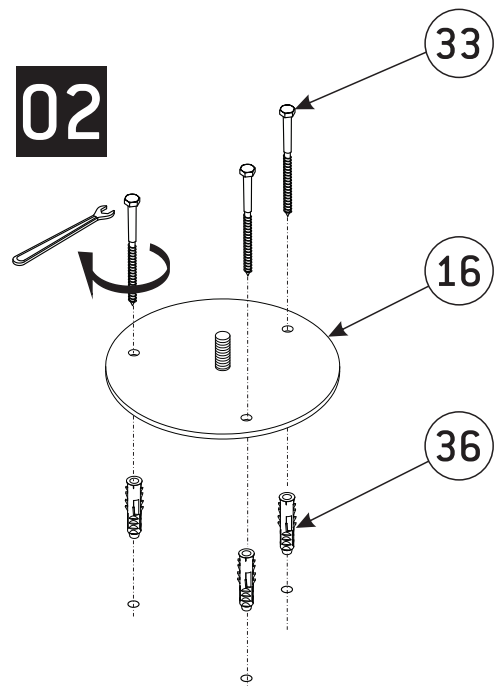

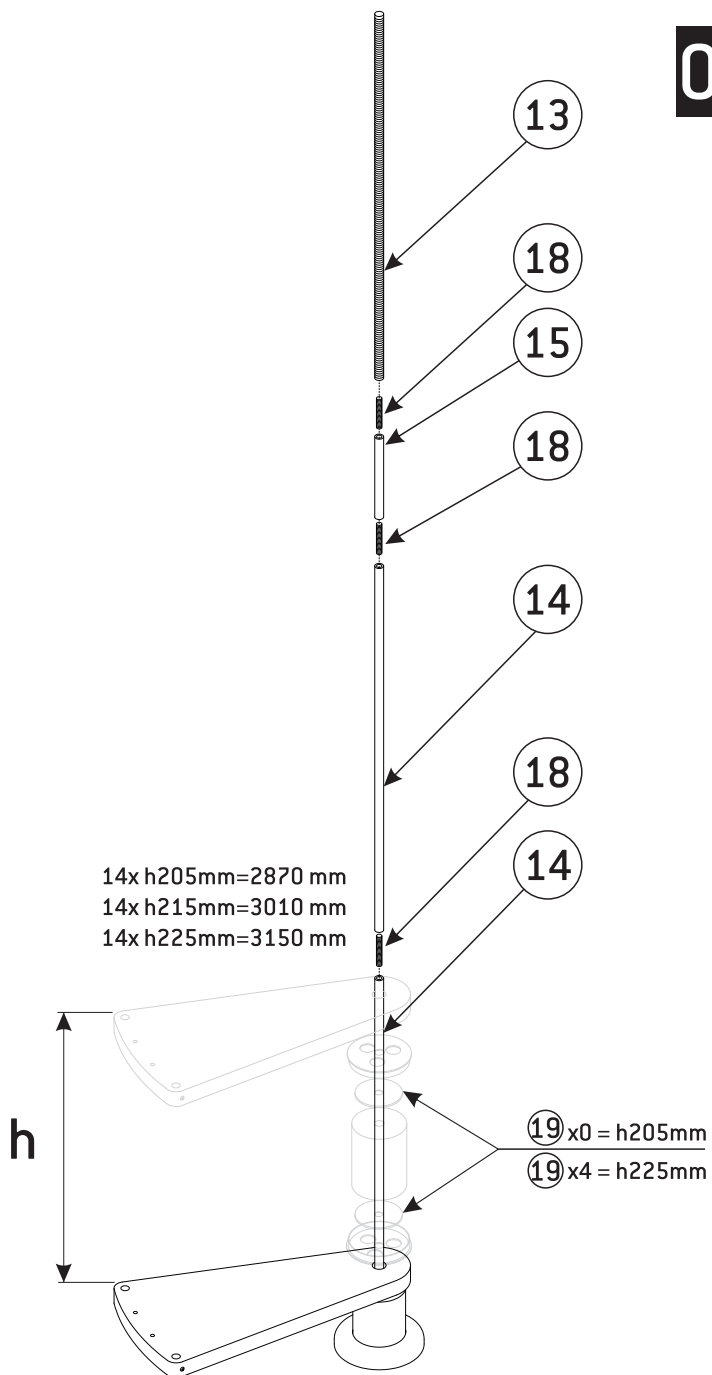
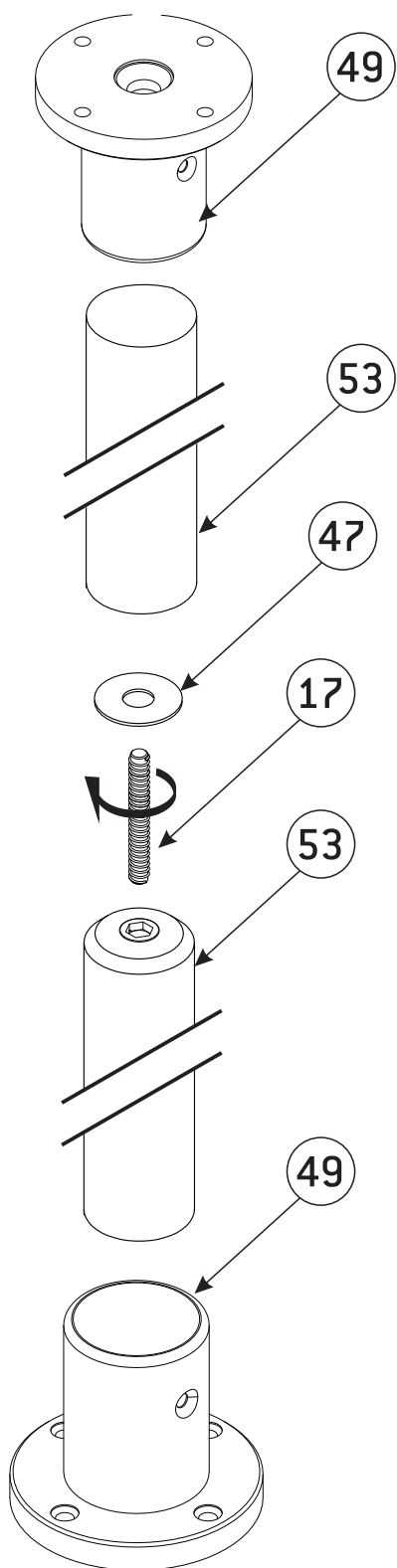

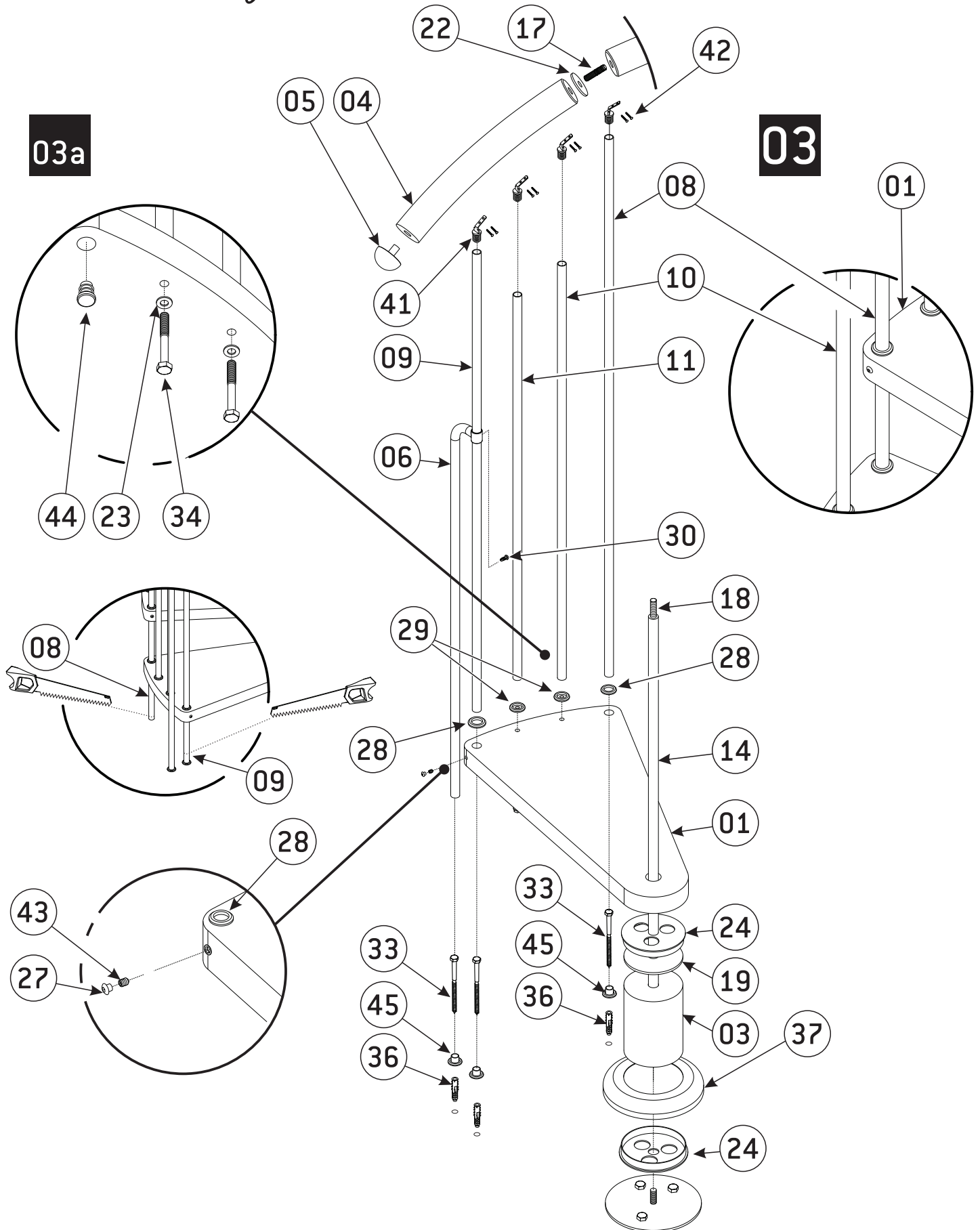

04

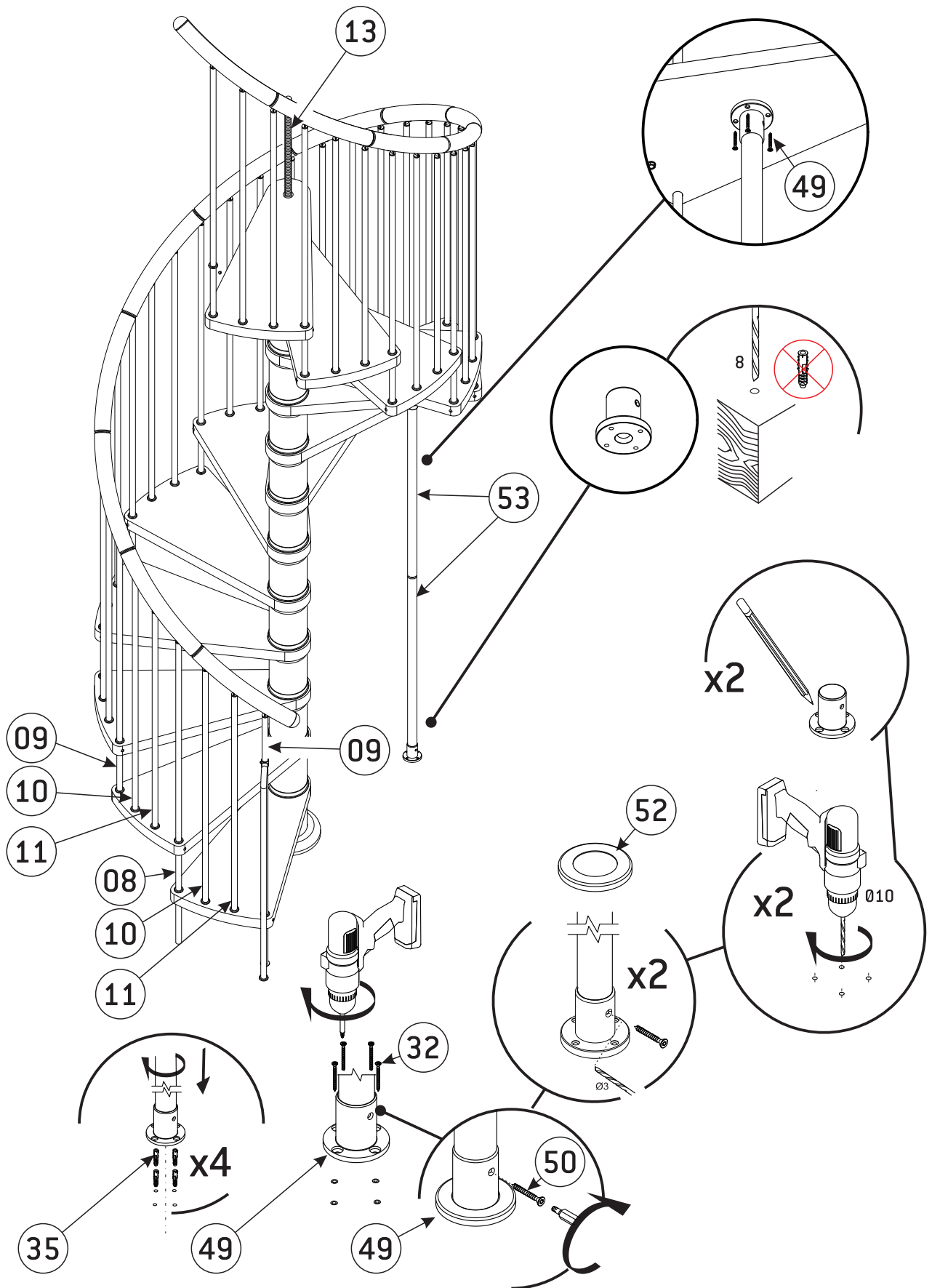

05

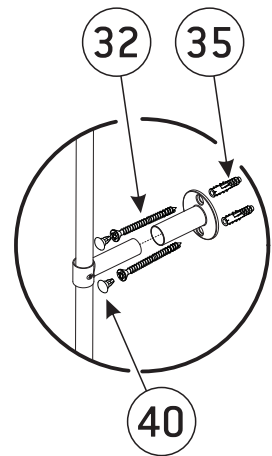
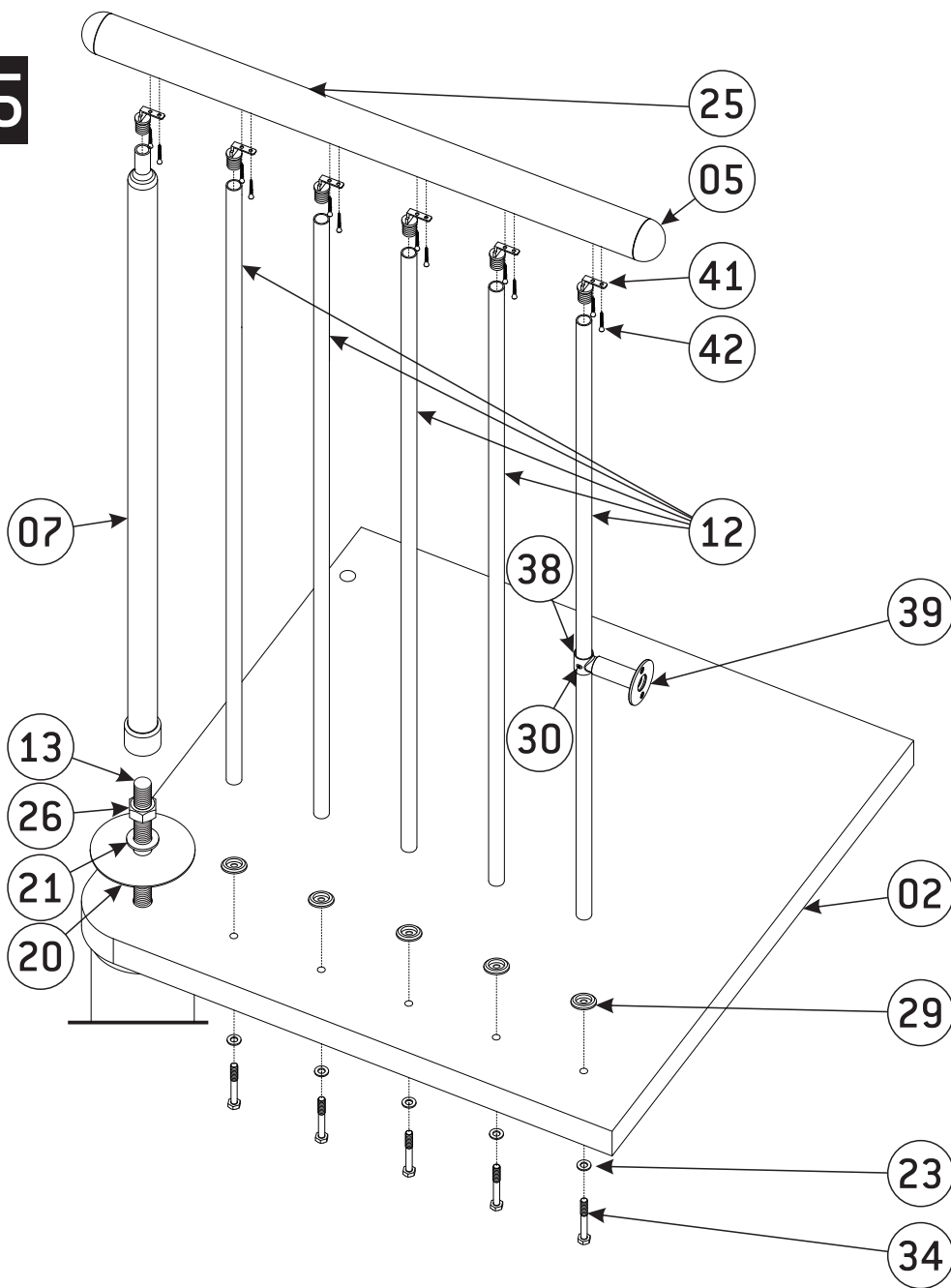

06

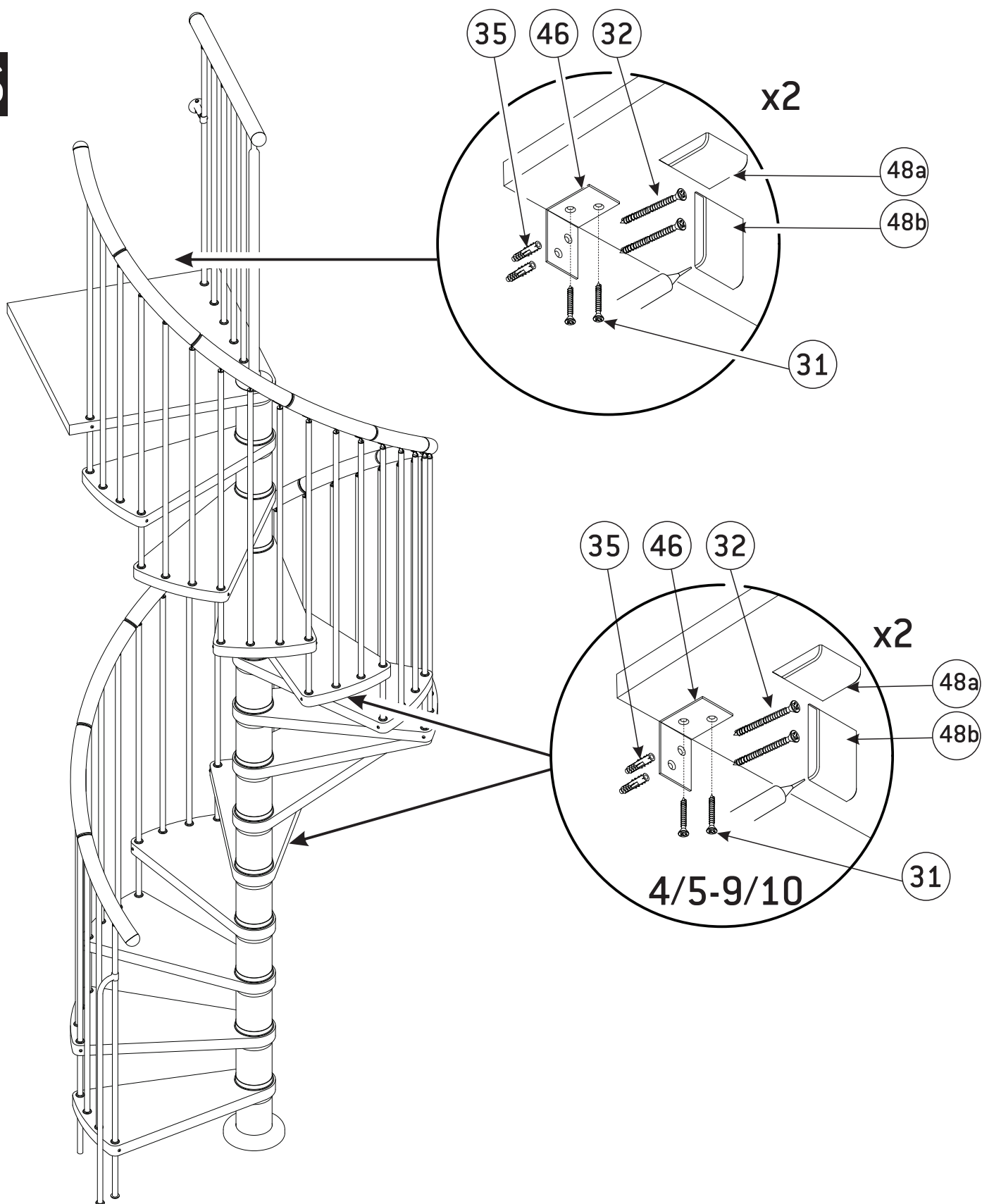

RUE GRIMARD,39 B-6061 MONTIGNIES-SUR-SAMBRE(CHARLEROI)-BELGIUM
 TEL: +32/71/25.39.60 FAX: +32/71/25.39.72 E-MAIL: info@sogem-sa.com