

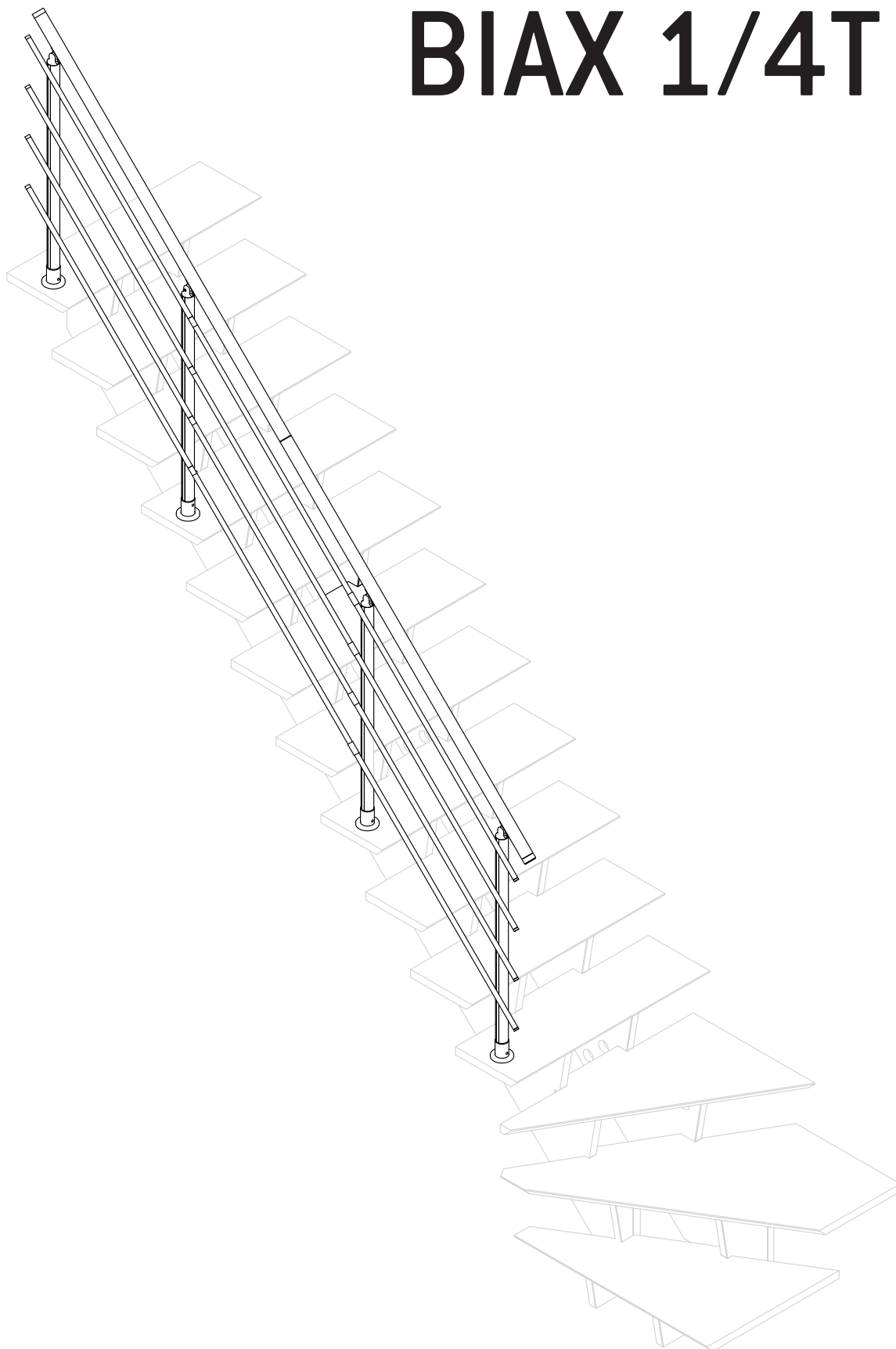

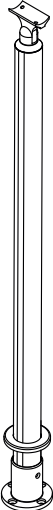







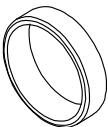
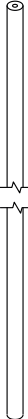



BIAX 1/4T

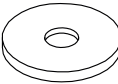

<p>25 040x840 x4</p> 	<p>26 040x1518 x2</p> 	<p>27 012x60 x2</p> 	<p>28 016x1013 x12</p> 	<p>29 012x60 x1</p> 	<p>30 05,8x60 x8</p> 
<p>31 M12x70 x4</p> 	<p>32 024x3 x4</p> 	<p>33 M12x19x22 x4</p> 	<p>34 04x30 x16+2</p> 	<p>35 036x4 x1</p> 	<p>36 020x40 x8</p> 
<p>37 016x12 x8</p> 	<p>38 04,2x45 x16+1</p> 	<p>39 40x99x23 x1</p> 	<p>40 04,2x13 x8</p> 	<p>41 04x25 x8</p> 	



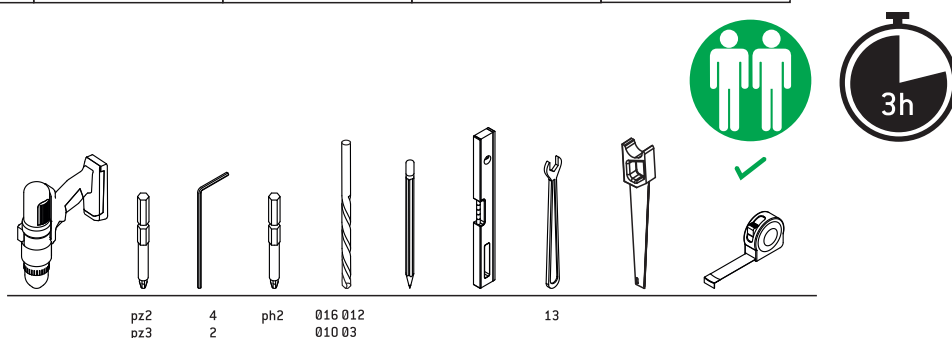
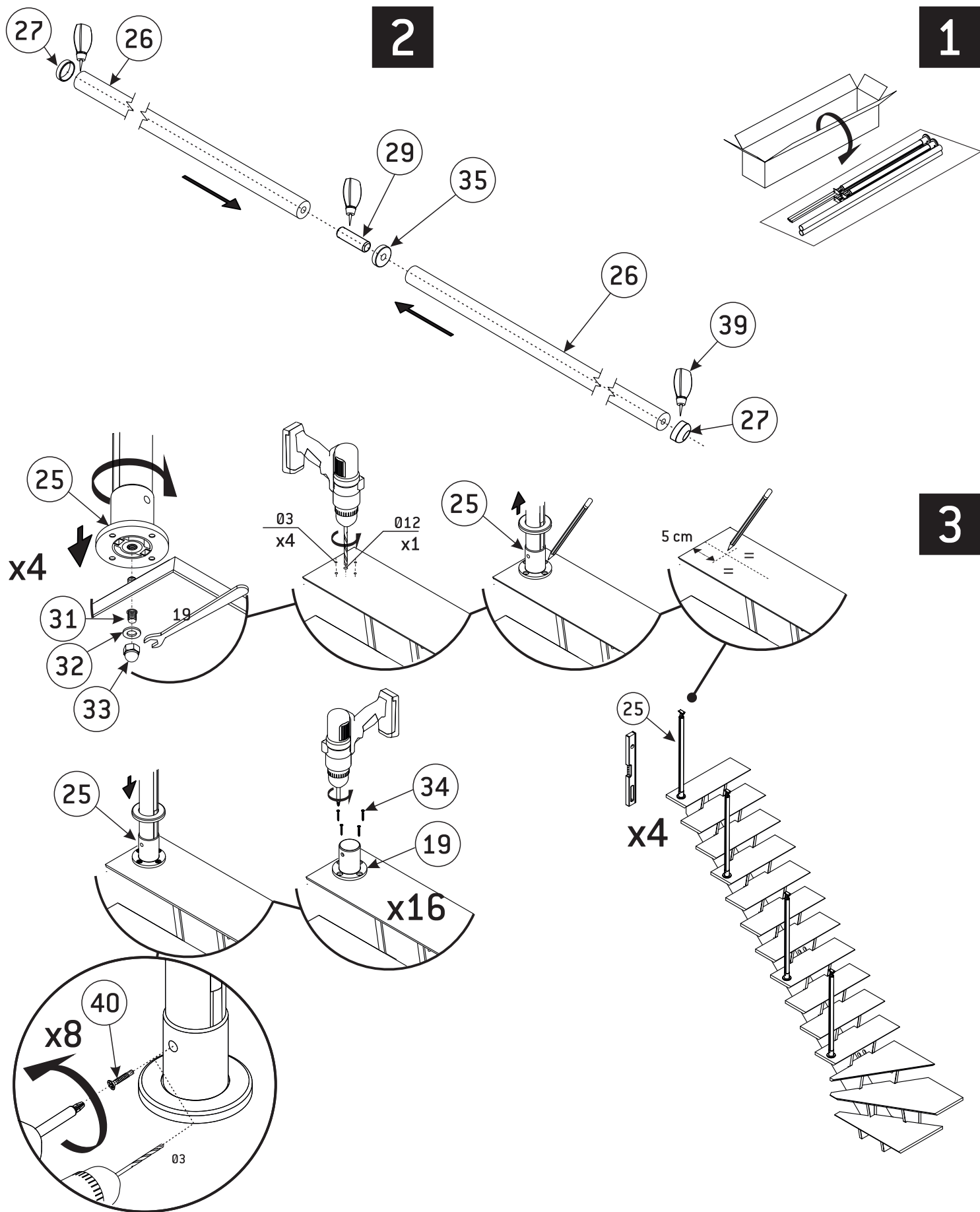

4

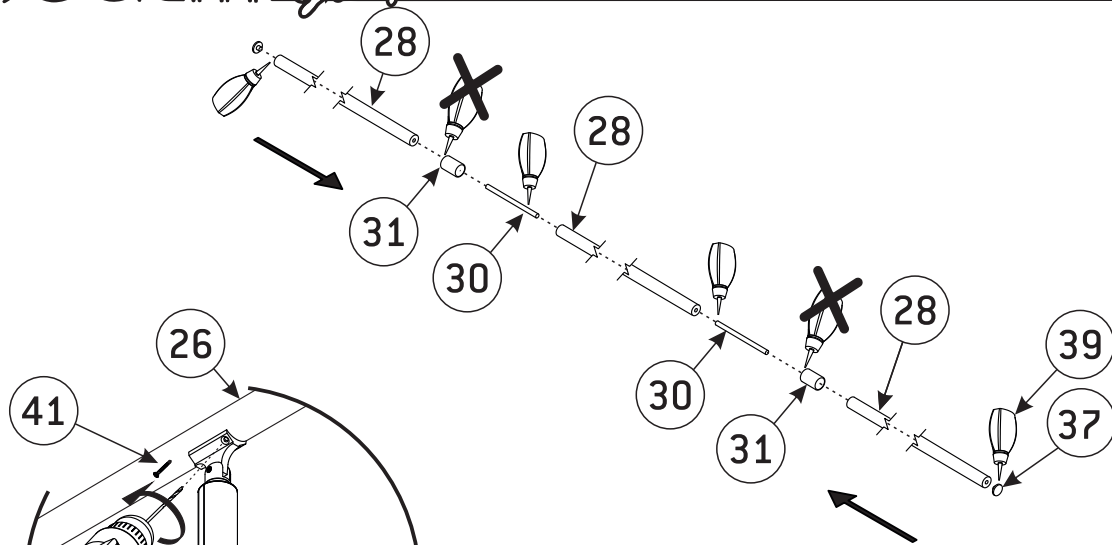

5

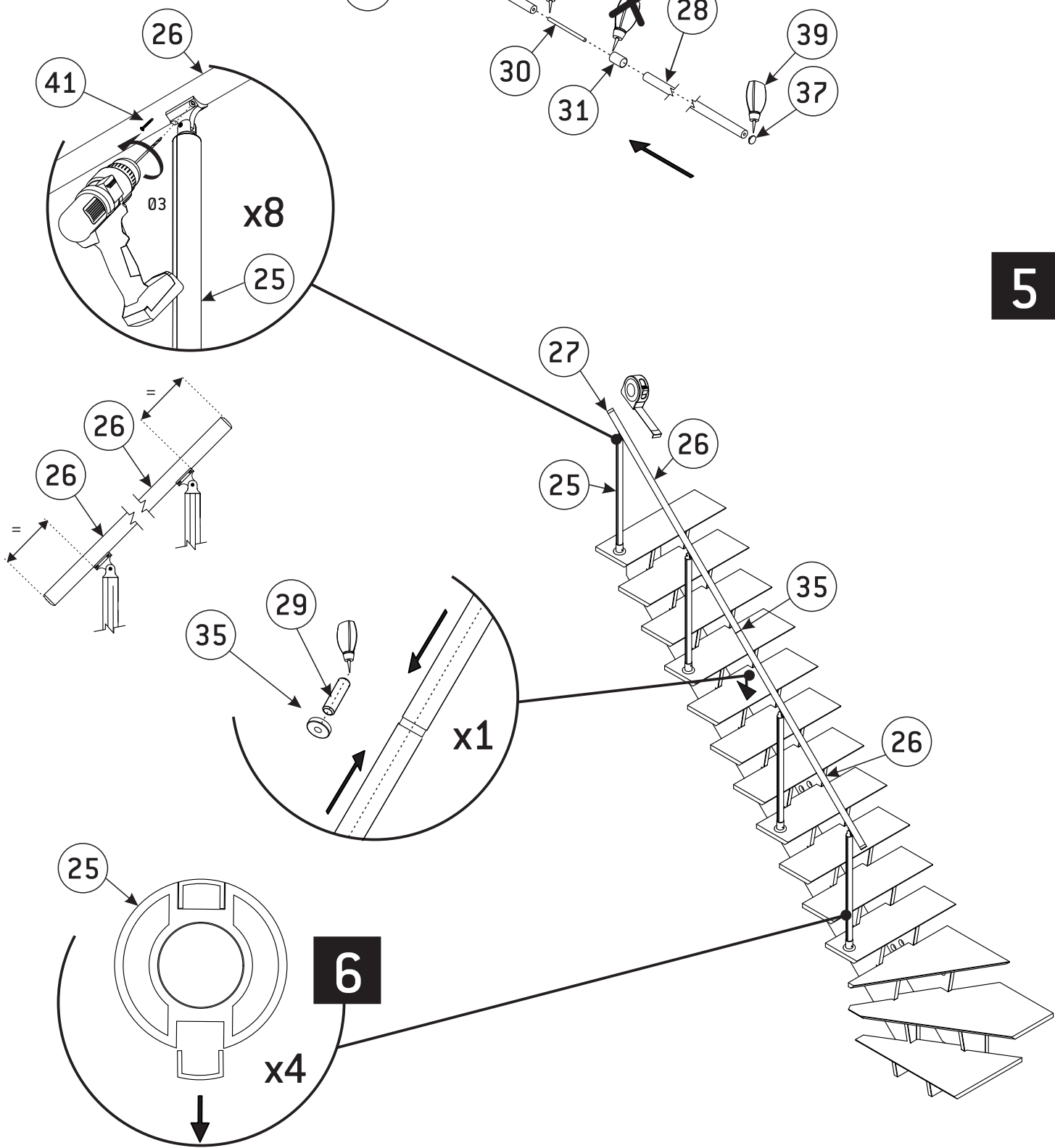

6

