

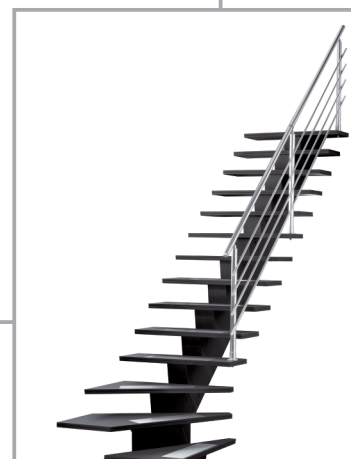

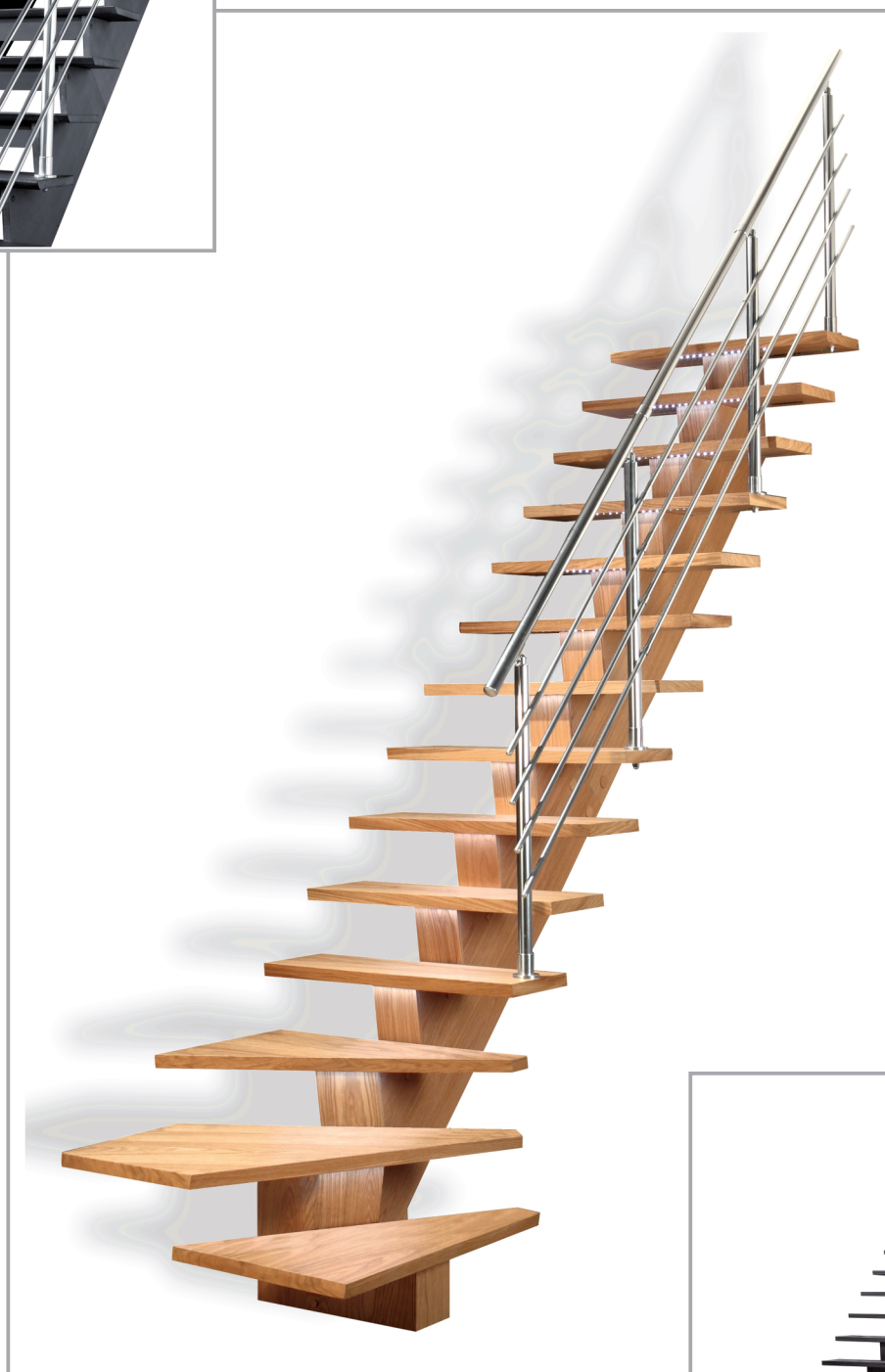





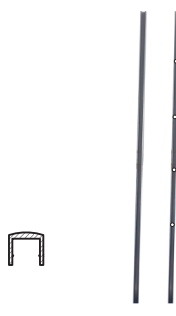

Video 

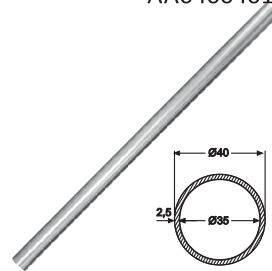
 www.sogem-sa.com

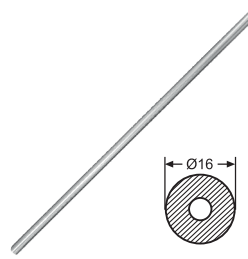

GOMERA / TAMBORA / KALEA / AUVERGNE
RAMPE ALU POUR ESCALIER 1/4T

<p>01 AA840040040</p>  <p>830xØ40mm =4</p>	<p>02 AA840012007</p>  <p>830x12x7mm 4+4 =8</p>	<p>03 AA050040070</p>  <p>50x40x70mm =4</p>	<p>04 AA070070012 AA070070070</p>  <p>Ø74,5xØ46,5x12mm =2 Ø72,5xØ40,5x70mm =2</p>
<p>05 AA074074040</p>  <p>M12x40mm =2</p>	<p>06 AA040040100 AA040040107</p>  <p>Ø40x1000mm =1 Ø40x1075mm =2</p>	<p>07 AA034034082</p>  <p>Ø34,6x82mm =2</p>	<p>08 AA040040014</p>  <p>Ø40x14mm =2</p>
<p>09 AA045045025</p>  <p>Ø45x25mm =2</p>	<p>10 AA016016107 AA016016920</p>  <p>Ø16x1075mm =8 Ø16x920 mm =4</p>	<p>11 AA020020050</p>  <p>Ø20x50mm =8</p>	<p>12 OG012012070</p>  <p>M12x70mm =4</p>
<p>13 AA006006060</p>  <p>Ø5,8x60mm =8</p>	<p>14 AA016016012</p>  <p>Ø16x12mm =8</p>	<p>15 OA019019022</p>  <p>hex19x22mm =4</p>	<p>16 OG024024003</p>  <p>Ø24x3mm =4</p>
<p>17 OG004004019</p>  <p>Ø4,2x13mm =28+1</p>	<p>18 OG004004045</p>  <p>Ø4,2x45mm =16+1</p>	<p>19 OG004004030</p>  <p>Ø4x30mm =16+1</p>	<p>20 PR040099023</p>  <p>40x99x23mm =1</p>

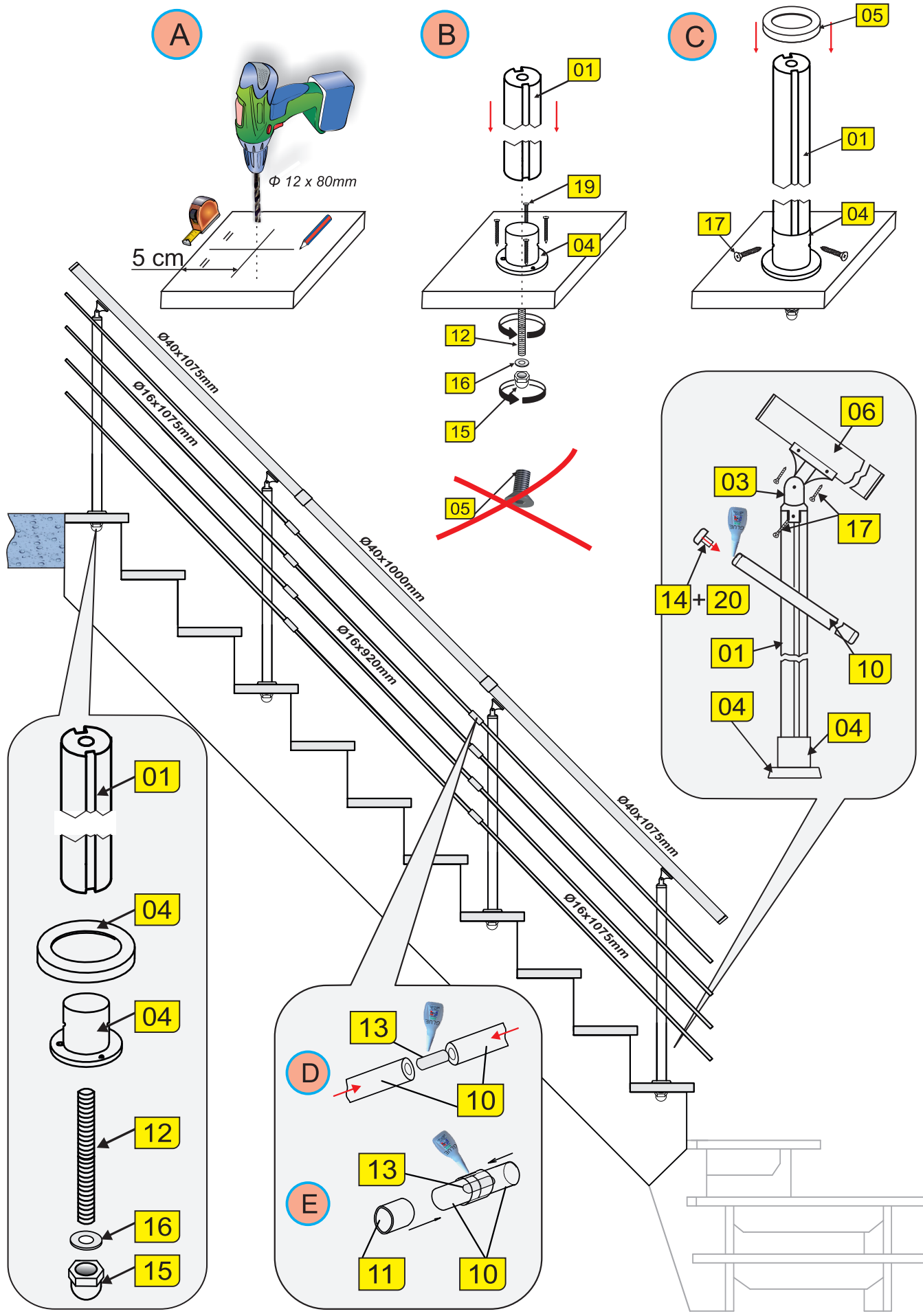

A

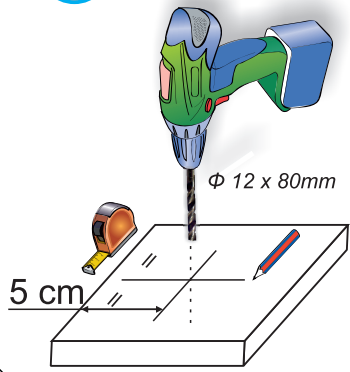

B

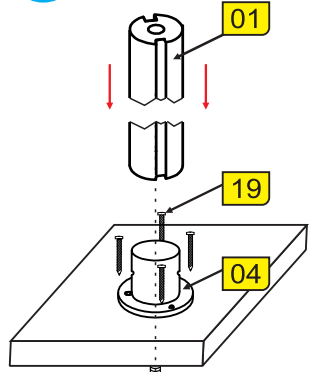

C

